



AWARD - WINNING CAD/CAM  
SOFTWARE FOR PACKAGING  
AND POP/POS DISPLAYS

# EngView Package & Display Designer Suite

for macOS and Windows

## Dream, Create, Succeed

business partner of  
**HEIDELBERG**



# Dream, Create, Succeed

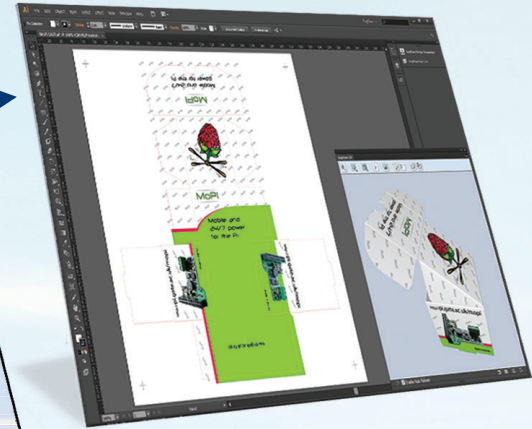
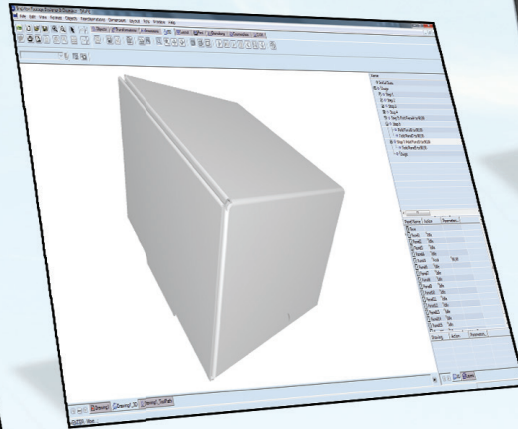
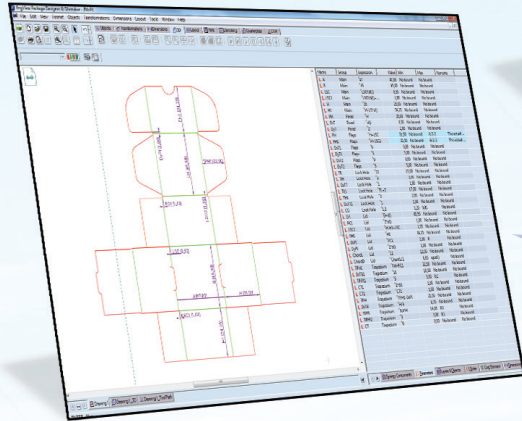



# EngView Package & Display Designer Suite

EngView Package & Display Designer Suite is specialized software for boxes and POP/POS displays. The supported materials are folding carton, corrugated board and rigid board.

Powered by an award-winning parametric design technology, EngView uses smart drafting and realistic 3D virtual modeling to easily take designers from the **DREAM** to the real concept.

A comprehensive library of parametric components and designs combined with Adobe Illustrator integration deliver a robust kit that enables professionals to **CREATE** innovative packaging and POP/POS displays.

EngView Package & Display Designer Suite is the most user-friendly solution that gives businesses the power to **SUCCEED**.

The suite is compatible with Microsoft Windows and MAC OS.

# Package Designer

The EngView Package Designer bundle is a selection of modules for structural design and prototyping of packaging from folding carton and corrugated cardboard.

Structural designers can do their challenging job with as few operations as possible benefiting from a full set of intuitive drafting tools, a library of parametric components and designs as well as 3D virtual prototyping. Integration with Adobe Illustrator ensures the correct application of artwork and the visualization of the 3D packaging structures.

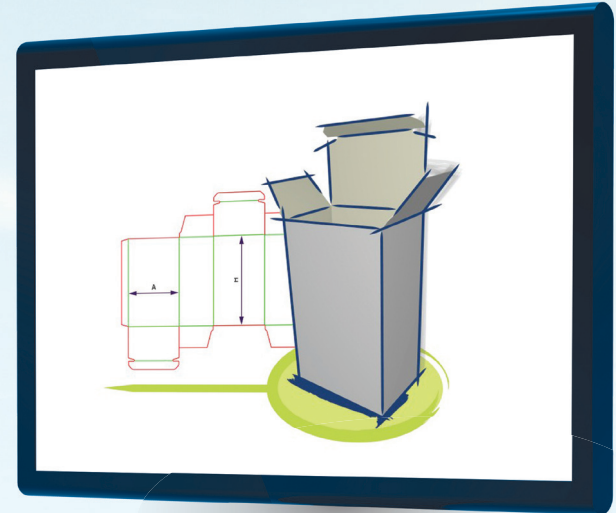

The sheet optimization functionality guarantees a minimal waste area — a feature that effectively saves machine time and contributes to substantial lowering of production costs.



## Features & Benefits

---

- Parametric libraries for packaging in millimeters and inches
- An integrated library index with sections for different materials
- Support of the ECMA and FEFCO codes, and a lineup of additional parametric designs
- Resizing and automatic structural modification by parameter editing
- A comprehensive set of geometrical drafting tools, transformations and dimensions
- A library of parametric components
- Smart drag & drop drafting with snap-to-size components
- An assistant for detecting errors in imported files
- Definition of the 3D model's folding sequence, navigation and animation
- Insertion of external 3D solid-product models
- Intersection with panels or solid 3D objects
- 3D dimensioning
- Realistic visualization of materials with their folded and cut edges
- Support of finishing effects — backing, varnishing, imprint, foils, special inks
- Integration with Adobe Illustrator
- Generation of 3D PDF
- Layout optimization



# Display Designer

EngView Display Designer is 2D and 3D software specially developed to improve POP/POS display production. It is integrated with Adobe Illustrator and supports the entire workflow, from the concept design and 3D assembly to artwork arrangement and machine output.

EngView Display Designer integrates a POP/POS parametric library to ensure the quality of the 2D structure and to speed up the design process. Multipart displays can be resized, structurally modified and applied to different materials such as corrugated and rigid board to fit customer requirements.

The assembly of the various display parts in the EngView 3D environment simplifies the virtual structure proofing.

Display Designer is integrated with Adobe Illustrator to link naturally the 2D design with the placement of artwork. The unique functionality of 3D visualization and image replication across the display parts enables graphic designers to see the result instantly.

To reduce production costs, Display Designer offers true shape nesting for optimal material use.

PDF documentation with illustrated instructions for the on-site display assembly wraps up the Display Designer's bid.



## Features & Benefits

- Parametric POP/POS displays and multipart structures for corrugated and rigid board
- A complete set of design features for creating and modifying 2D structures
- Smart drafting based on parametric components
- A 3D environment for realistic visualization of POP/POS displays
- Generation of 3D PDF for virtual proofing
- Integration of 2D and 3D features within the Adobe Illustrator environment
- Support of graphic replication, finishing processes and dual side artwork placement
- Nesting layout for arrangement of multipart POP/POS displays automatically onto a set of sheets
- Generation of documentation for production and assembly instructions

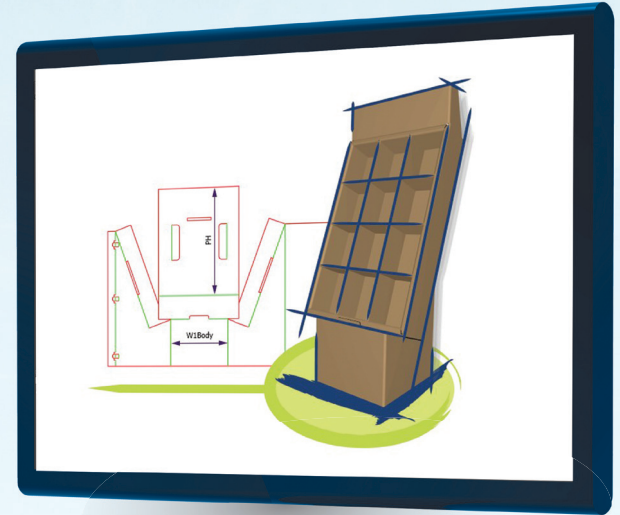

# Standard

The EngView Designer Standard bundle comes with a set of modules tailored to specific needs of the producers of packaging and POP/POS displays. With a mix of conventional and smart drafting tools, realistic 3D modeling and Adobe Illustrator integration, the Standard bundle is the best option for professionals who need a complete solution.

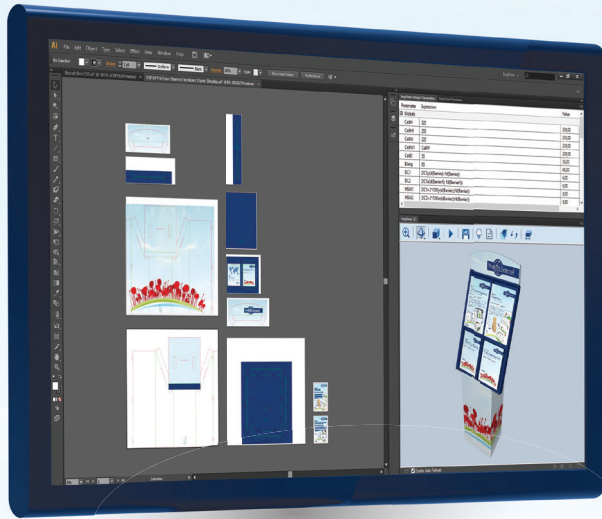

## Features & Benefits

- Parametric libraries for packaging and POP/POS displays
- Smart drafting with drag & drop and snap-to-size components
- 3D modeling and generation of 3D PDF
- Integration with Adobe Illustrator
- Layout optimization
- Nesting of multipart designs
- Documentation tools for integrated preparation of production and assembly instructions



# Art



The Art bundle is a combination of functionalities that gives graphic designers the flexibility to work directly in Adobe Illustrator with files from the packaging and POP/POS displays parametric libraries. Native EngView files are opened in Adobe Illustrator without conversion and are resized by editing their own parameters.

Focused on the visual side of the design process, the Art bundle offers intuitive 3D prototyping with realistic visualization of the material, print and finishing effects in the Adobe Illustrator environment. The integration ensures that the powers of graphic and CAD software systems complement one another – a process that at once increases productivity and requires minimal effort.

## Features & Benefits

- Conversion-free opening of native EngView files
- Resizing of designs directly in Adobe Illustrator
- Immediate inspection of any change in 3D
- Artwork replications and finishing effects
- Front and rear artwork placement variants
- Generation of 3D PDF

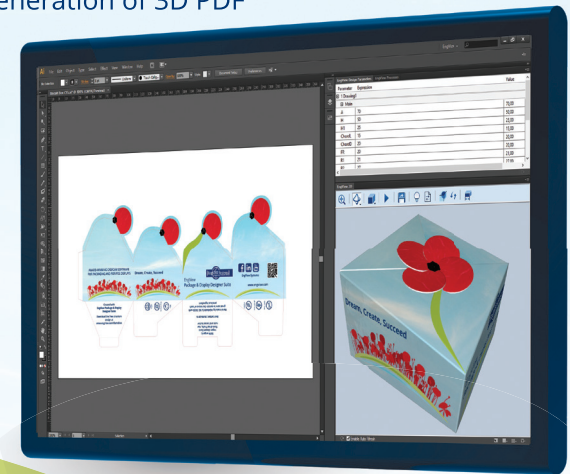

# Professional

The EngView Professional bundle provides full support of the conventional design process and creation of custom parametric design libraries for packaging and POP/POS displays.

Professional is configured as a set of design, 3D prototype, layout, samplmaking and cost estimation functionalities. Integration with Adobe Illustrator enriches the work on graphic and structural designs.

Project Organizer, included in this bundle, helps industry professionals maintain a structured database of all project-related documents, orders and communication.

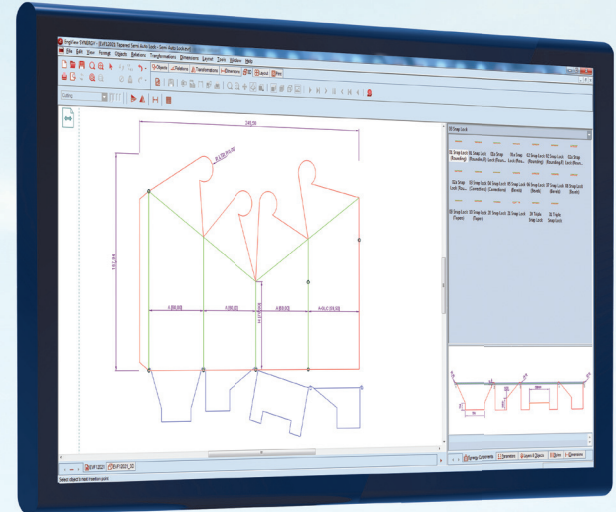

# Ultimate

This comprehensive kit of drafting and production functionalities offers all the design, artwork and production-related capabilities of EngView Suite. Packaging and POP/POS designers and producers have the full set of tools necessary for creating and manufacturing their products. The package also suits the needs of diemaking producers, containing the entire string of diemaking, counterplate and stripping die design modules.

Ultimate also gives designers the freedom to use EngView Synergy, a CAD tool for creating resizable designs. The application is developed on the award-winning Variational and Parametric Design Technology, in which objects are drawn and modified by using parameters for various constructional characteristics. The designing process consists in the automatic rebuilding and redrawing of entire structures by the simple modification of parametric data in an existing model. The technology also underlies the EngView libraries for packaging and POP/ POS displays and enables designers to develop their own parametric catalogs.

To complete the workflow, all processes are effortlessly managed in an integrated product data management system, EngView Project Organizer.

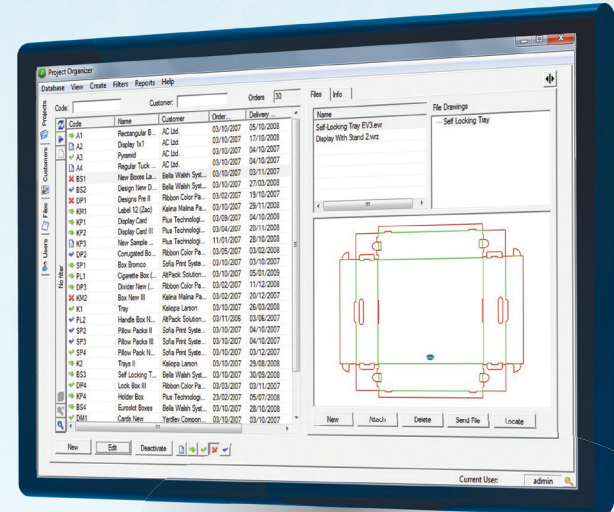

# Diemaking

The EngView Diemaker bundle is meant for design and manufacturing of steel-rule dies and related tooling. It supports diemaking professionals through the entire process – from 1 up design to optimum layout to dieboard design, counterplates and stripping dies.

This configuration is best suited for diemaking companies working with CNC machines – cutting lasers, waterjets, rule bending machines and plotters. The included CAM toolpath generation is optimized to significantly save machine time. The bundle offers management of batch cutting of multiple dies to reduce process time and optimize material use.

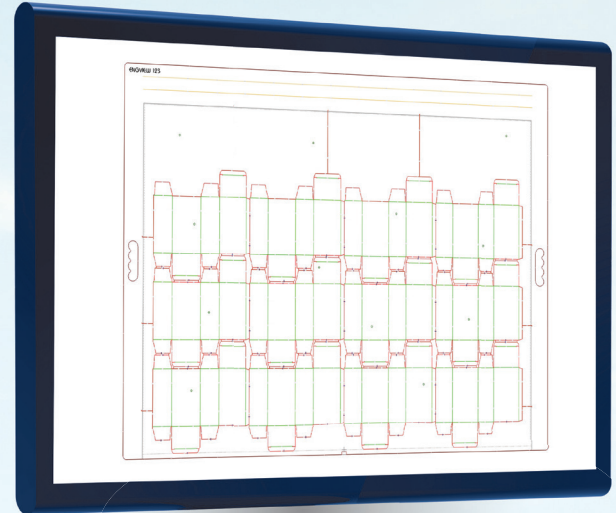

## Features & Benefits

- Catalogs of predefined dieboards
- Automatic generation of cutting dies with bridges and nicks
- Synchronized generation of stripping dies – male, female and front stripper
- Specialized parametric components for the cutting and stripping dies
- Cost estimation with predefined cost models
- Generation of multi-page documentation
- Export to production file formats, among them layered DXF, CF2 and DDS3
- Drivers for CNC machines

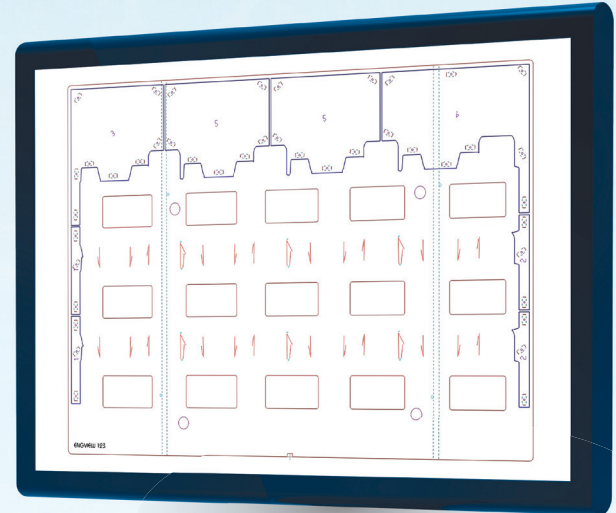

# EngView PACKAGE & DISPLAY DESIGNER SUITE

Any combination of modules can be ordered.

The modular structure allows users to create the most cost-efficient configuration that meets their exact requirements.

MODULES

BUNDLES

		Art	Package Designer	Display Designer	Designer Standard	Professional	Ultimate	Diemaker
	Library of Packaging Designs	Parametric designs for folding carton and corrugated cardboard, including the full ECMA and FEFCO codes. Standards appropriate for PVC and corrugated plastics are also available.		■	■	■	■	■
	Library of Displays	A collection of parametric POP/POS displays and complex multipart structures – furniture, walls, booths, kids' corners – for corrugated and rigid board.		■	■	■	■	
	Drafting with Parametric Components	A complete set of design features for creating and modifying 2D structures. Smart drafting based on a rich library of parametric components.			■	■	■	■
	3D Presenter	A 3D environment presenting realistically the final look of the packaging and displays along with their applied graphics, finishing effects and external 3D objects. Generation of 3D PDF for customer inspection.		■	■	■	■	
	Integration with Adobe Illustrator	Integration of EngView's 2D and 3D features within the Adobe® Illustrator® environment. Support of graphical replications, finishing processes and dual side artwork placement. Generation of 3D PDF.		■	■	■	■	
	Layout Optimizer	Optimized laying out of 1 ups on sheets corresponding to different machines. Automatic layout generation for comparing and selecting the best option.			■	■	■	■
	Nesting Layout	A true shape layout optimizer that arranges multipart POP/POS displays automatically onto a set of sheets taking into account the defined parameters and settings.			■	■	■	
	Cost Estimator	Calculation of production cost according to customer parameters and rules. A set of predefined cost models for layout and diemaking jobs.				■	■	■
	CAM	Control of all makes and models of cutting plotters, lasers and other CNC machines. Generation of optimized toolpath and NC.				■	■	■
	Varnish Blanket Design	Automatic generation of rubber varnish blankets.				■	■	
	Dieboard Design	Design of dieboards with bridges and nicks, stripping and balancing rules. A library of quick features for easy access to additional objects and tools.					■	■
	Counterplate Design	Automated design of pertinax counterplates. Features for 160-degree toolpath and edge smoothing.					■	■
	Stripping Dies Design	Complete set of stripping tools, including male, female and front-stripping dies.					■	■
	EngView Project Organizer	A product data management system integrated with EngView Package & Display Designer. It organizes information, files and documents that relate to customers and their orders.					■	■
	EngView Synergy	An award-winning technology for parametric design with resizable components. Creation of parametric components and design libraries.					■	■

# About EngView



EngView Systems is a software company that specializes in the development of CAD/CAM systems and products for the measurement and aluminum extrusion industries. The company was formed in 1999 and has since focused on creating unique, useful and profit-oriented solutions based on the award-winning technology for variation and parametric CAD. Over the years EngView has acquired a sizable market share in the packaging design industry, and its flagship product, EngView Package & Display Designer Suite, is among the world's preferred choices. Known globally for its innovative technologies and recognized as a reliable long-term partner, EngView has established a community of trusted customers and business allies.



*EngView Systems is a Sirma Group Company*

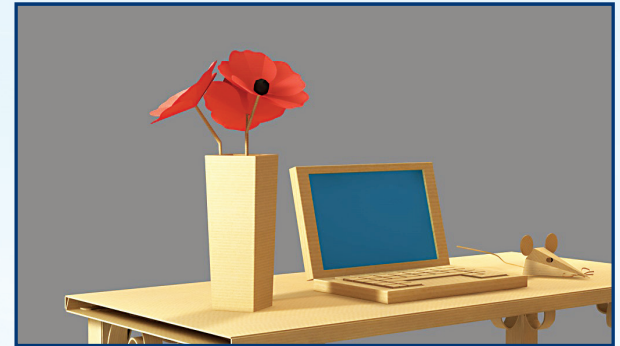



*The EngView technology of variational and parametric CAD was awarded with the prestigious European Information Society Technology Prize.*

### **EngView Systems Sofia JSC**

Sofia, Bulgaria

tel: +359 2 976 8312

e-mail: [info@engview.com](mailto:info@engview.com)

### **EngView Systems USA**

Rochester, NY, USA

tel: +1 514 343 0290

e-mail: [info@engview.com](mailto:info@engview.com)

### **EngView Systems Corp.**

Montreal, QC, Canada

tel: +1 514 343 0290

e-mail: [info@engview.com](mailto:info@engview.com)

### **EngView Systems Latin America**

Bauru – SP, Brazil

tel: +55 14 3010 88 48

e-mail: [suporte@engview.com](mailto:suporte@engview.com)

© EngView Systems Corp., a SIRMA Group Company. All rights reserved. Adobe, Adobe logo and Illustrator are either registered trademarks or trademarks of Adobe Systems Inc. in the United States and/or other countries.

The Heidelberg Logo is a registered trademark of Heidelberg Druckmaschinen AG in Germany and in other countries.

**EngView products are Microsoft Windows and MAC OS X compatible.**

[www.engview.com](http://www.engview.com)



EngView Systems